

RAC

2400W Pressure Washer

RAC-HP125



Waste electrical products should not be disposed of with household waste.
Please recycle where facilities exist.



Check with your local authority or retailer for recycling advice.

SAFETY AND WARNING INFORMATION

General Safety Rules

WARNING: Read the instructions fully before using the product for the first time. Failure to follow the instructions may result in fire, electric shock and or serious injury. We recommend the user wears safety equipment during use. We recommend the product be used with a RCD (Residual Current Device).

Please Retain These Instructions For Future Use And Referral

- This appliance is not intended for use by persons (including children) with reduced physical, sensory or mental capabilities, or lack of experience and knowledge, unless they have been given supervision or instruction concerning use of the appliance by a person responsible for their safety. Children should be supervised to ensure that they do not play with the appliance.
- When operating the unit in high pressure mode the lance may cause kickback. Therefore please ensure that you hold the spray gun firmly. When using the unit we recommend that other people are at least 10m away from the working area.
- High-pressure jets can be dangerous if misused. The jet **MUST NOT** be directed at yourself, other people, animals, live electrical equipment or the pressure washer itself. The trigger gun safety lock prevents the trigger from accidentally being engaged. This safety feature does not lock trigger in the 'on' position.
- Do not use the pressure washer if the supply cord or other important parts are damaged (e.g. high pressure lance or hoses). Never carry your pressure washer by the cord.
- Do not disconnect the high-pressure hose whilst the system is under pressure. This system is capable of producing 1600PSI. To avoid rupture and injury, do not operate this pump with components rated less than 1600PSI working pressure (including but not limited to spray guns, hose and hose connections.)
- Do not use acids or flammable liquids in the machine.
- When using a pressure washer always ensure that your water connection is protected by a backflow preventer (as per water byelaws). This will avoid possible contamination of your water supply. Use cold water feed only.
- Protect the unit against freezing, avoid storing the machine where it may be susceptible to frost.
- Prior to starting the pressure washer in cold weather, be sure ice has not formed in any part of the equipment.
- The unit must continuously run with water. Dry running will cause serious damage to the seals.

IMPORTANT: The pressure washer is equipped with an auto stop device. When the trigger is released it will open the power circuit to the motor and cause the pressure washer motor to stop. The motor will resume when the trigger is pulled. The pressure washer is also equipped with a main power ON/OFF switch located on the unit. It should always be moved to OFF position when the pressure washer is not being used.

This product is a class II product-double insulated. No means of grounding (to earth) is provided on this product nor should it be added. Only a qualified person should carry out servicing. If an extension lead is to be used with this product, please ensure:

Use only extension cords that are intended for outdoor use.

Completely unwind the cable from the drum to allow for full current rating of the extension cable.

To reduce the risk of electrocution, keep all connections dry and off the ground.

Do not touch plug with wet hands

Hose: Water supply hose must be at least ½" in diameter with a minimum recommended length of 7.5 meters and be fitted with a suitable coupling that matches the male quick fit connector.

- Use only original spare parts from the manufacturer or approved by the manufacturer.
- **WARNING:** High pressure hoses, fittings and couplings are important for the safety of the appliance. Use only hoses, fittings and couplings recommended by the manufacturer.

COMPONENTS



Component List

- | | |
|-----------------------------|------------------------------|
| 1. Detergent container | 11. Adjustable lance |
| 2. Water supply inlet | 12. Cleaning needle |
| 3. ON/OFF switch | 13. Patio cleaner |
| 4. High pressure outlet | 14. Quick connector (Female) |
| 5. Trigger gun | 15. Quick connector (Male) |
| 6. High pressure hose | 16. Lance holder |
| 7. Rotary brush | 17. Lance rest |
| 8. Fixed brush | 18. Cable holder |
| 9. Lance extension | 19. Pack of 5 screws |
| 10. Patio extension cleaner | |

Technical specification

Rated voltage:	220 - 240V	Supply water temperature:	0-50°C
Rated power:	2400W	Nozzle spray angle:	0-90 degree
Rated frequency:	50HZ	Max output flow rate:	6.6L/min
Protection class:	II	Net weight(machine only):	10kg
Degree of protection:	IPX5	Cable length:	5 m
Permissible pressure:	16.5 Mpa / 165 Bar	Hose length:	8 m
Rated pressure:	11.0 Mpa / 110 Bar	Noise value:	92Lpa
Inlet pressure:	1.5 - 4 Bar / 0.15 – 0.4 MPA	Noise value:	94Lwa
Vibration:	1.0 M/S		

ASSEMBLY

Before carrying out any assembly or disassembly of the unit please ensure that the unit is not connected to the electrical supply.

Assembling your machine

1. Using a pozi drive screwdriver, screw the cable holder (18) onto the back of the unit, using the 4 screws provided (19).
2. Lance holder (16) and lance rest (17) are supplied loose and need to be fitted into the appropriate slots provided on the unit, Fig 1. The lance rest (17) is retained in position using one screw (19).
3. Connect the high pressure connection hose (6) to high pressure outlet (4) as shown in Fig 1.
4. Connect the trigger gun (5) to the high pressure hose using two 17mm spanners (not supplied). Fig 2
Note: Using a spanner on the trigger gun connector and a spanner on the hose connector ensures that you do not stress the internal components when tightening (spanners not included).
5. Fit the lance extension (9) into the trigger gun (5) by pushing the lance extension into the trigger gun and locating the lugs at the same time, then turn clockwise to lock into position, Fig 3
6. Fit the adjustable lance (11) into the lance extension (9) by pushing the adjustable lance into the lance extension and locating the lugs at the same time, then turn clockwise to lock into position.
Note: Do not fit lances when the power is on.
7. Fit the quick connector male (15) as per Fig 4 and make sure it is fully tightened
8. Connecting to the water supply
Connect the quick connector female (14) to your garden hose, then connect to the quick connector male (15) as per Fig 5.

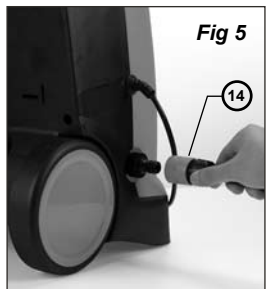
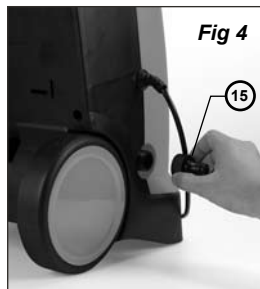
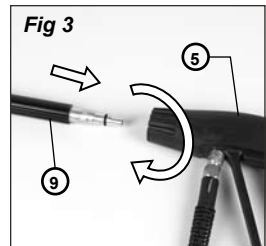
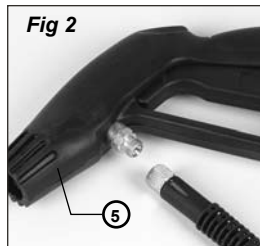
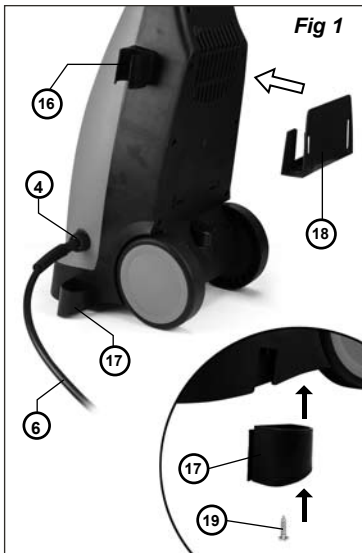

OPERATING INSTRUCTIONS

Note:

Before connecting to the mains power supply please ensure that the ON / OFF switch is in the OFF position (fig 6) and the water supply is connected and is turned on. Running the pressure washer without any water supplied to it will damage the pump.

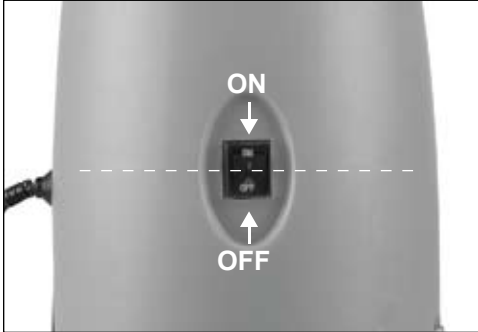

Fig 6

Instructions for use

- With the unit fully assembled, ensure that the unit is switched OFF and is connected to the mains supply and the water supply. Pull the trigger a few times to expel any air trapped in the system.
- Ensuring that the trigger is released, switch ON the pressure washer. The unit is now ready to operate by pulling the trigger.

Note:

The motor only runs when the trigger is operated. When the pressure washer is not in use, actuate the gun lock for safety reasons (Fig 7). Switch the unit OFF when not in use for extended periods of time. Never operate the pressure washer without the water supply connected and turned on.

Fig 7



Helpful Hints

Before starting cleaning remove any objects which could create a hazard.

Ensure that all doors and windows are closed (where appropriate).

The adjustable lance allows you to use a variety of spray patterns from a fan to a pencil jet (fig 8). When using the pressure washer to clean decking, patios, vehicles, etc., always start by using the fan spray and begin spraying from a minimum 30cm away to avoid damaging the surface of the material to be cleaned.

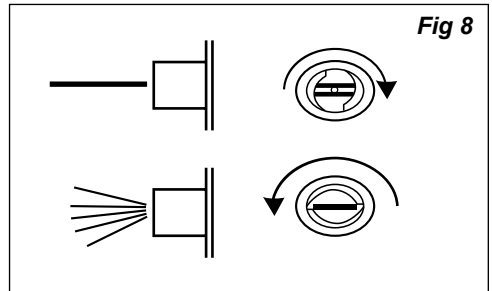

The spray is adjustable from a pencil jet spray to fan spray by tuning the nozzle shown (Fig 8).

WARNING: Do not adjust the nozzle while the trigger is squeezed.

The pressure of the spray on the surface you are cleaning increases as you move the nozzle closer to the surface. We recommend that for most cleaning applications a 45° spray angle should be used to avoid damaging the surface being cleaned. Spraying directly head-on tends to cause dirt particles to embed in the surface.

Applications

Warning: Always check that NO damage can occur to the items you are intending to clean.

Always use safety wear for your personal protection.

General applications for this product are domestic cleaning tasks:

Cars, motorbikes, caravans, and boats

Patio's, fences, garden walls, pathway, driveways – particularly block driveways

Roofs, brickwork and guttering

Garden tools, furniture and barbecues

Animal pens

ADJUSTABLE LANCE

Low pressure Setting:

Please make sure the trigger is released and no water is coming out, then turn the rear part of the spray nozzle clockwise (Fig 14) to set to low pressure.

This setting is used for releasing soap from the soap dispenser in a large volume.

High Pressure Setting:

Please make sure the trigger is released and no water is coming out, then turn the rear part of the spray nozzle anti-clockwise (Fig 13) to set to high pressure.

This setting is for obtaining a pencil or a fanned jet at high pressure.

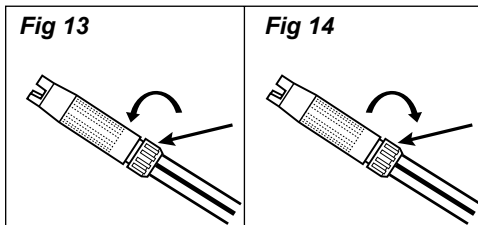

ADJUSTING FAN PATTERN

The angle of spray coming out of this lance may be adjusted by rotating the nozzle. This will vary the spray pattern from approximately a 0° narrow high impact stream to a 60° wide fan spray. (See Fig 9)

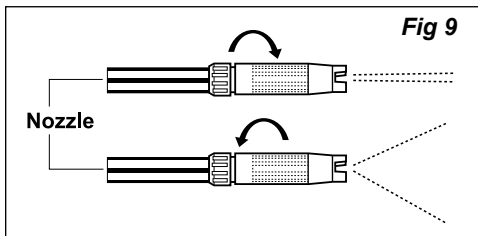

Figure 8 – Adjusting nozzle for fan pattern

A narrow stream has high impact force on the cleaning surface and results in maximum deep cleaning in a concentrated area. However, this narrow high impact spray must be used cautiously, as it may damage some surfaces.

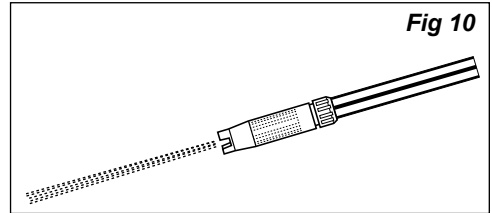

Figure 10 – Narrow high impact stream

A wide fan pattern will distribute the impact of the water over a larger area, resulting in excellent cleaning action with a reduced risk of surface damage. Large surface areas can be cleaned more quickly using a wide fan pattern.

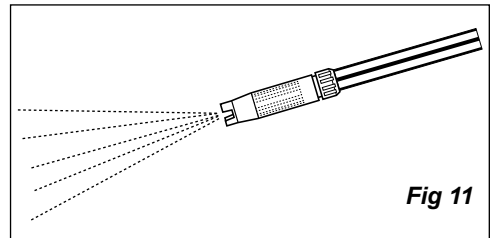

Figure 11 – Wide fan pattern

NOZZLE CLEANING INSTRUCTIONS

A clogged or partially clogged nozzle can cause a significant reduction of water coming out of the nozzle and cause the unit to pulsate while spraying. To clean out the nozzle:

- Turn off and unplug the unit.
- Turn off the water supply and relieve any pressure within the unit by squeezing the trigger 2-3 times
- Separate the lance from the gun.
- Rotate the nozzle to the narrow stream setting. This opens up the fan blades.
- Using the cleaning needle (12) or an unfolded paper clip, insert the needle into the nozzle hole and move it back and forth until the debris is dislodged (Fig 12).

Fig 12

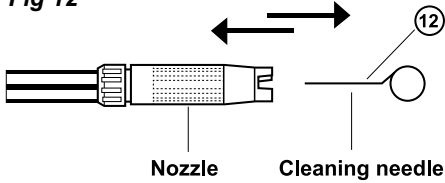

- Remove additional debris by back-flushing water through the nozzle. To do this, place the end of a garden hose (with water running) to the end of the nozzle for 30-60 seconds.

Brushes

Your RAC pressure washer is supplied with a rotary brush and a fixed brush. Both have soft bristles and can be used in conjunction with the soap dispenser to apply detergent to the surface you are cleaning. These are ideal for cleaning car bodywork, windows etc. The brushes connect directly to the lance extension (9).



WARNING

- Ensure the brushes are clean and free from debris
- Ensure the surface to be cleaned is sound and will not be damaged by the brushing action. Test on an inconspicuous area first
- Any grit or debris on the surface to be cleaned or in the brush can cause damage to that surface. Please ensure both are checked prior to cleaning.

Patio Cleaner Assembly

1. Fit the patio cleaner extension (10) onto the patio cleaner (13).
Push and turn to lock the bayonet fitting.

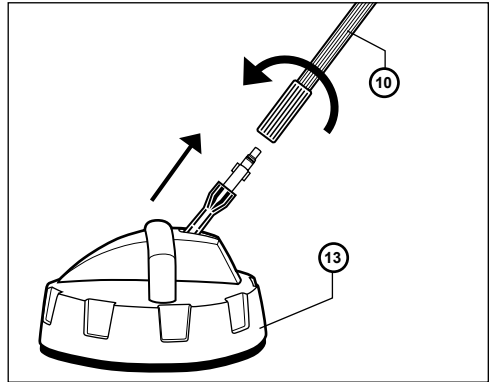

2. Connect the lance extension (9) on to the patio cleaner extension (10) then attach the trigger gun (5).

Note: All these fittings are bayonet fittings which push in then twist to lock.

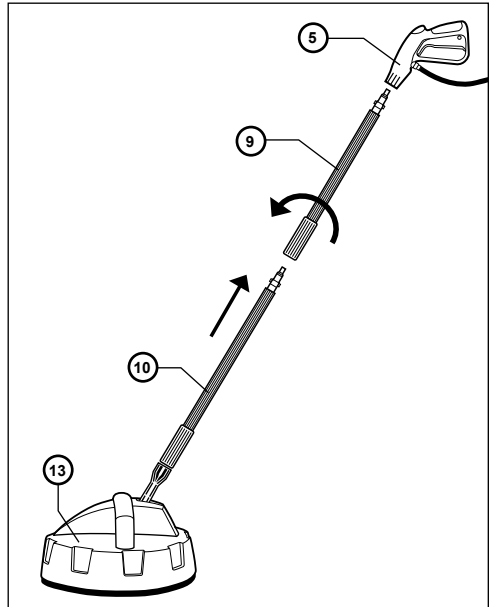

Note: Prior to using the Patio cleaner always check that you will not damage the surface area on an inconspicuous test area first.

HOW TO AVOID DAMAGING SURFACES

Damage to cleaning surfaces occurs because the impact force of the water exceeds the durability of the surface. Never use a narrow high impact stream or a turbo/rotary nozzle on a surface that is susceptible to damage. Avoid spraying windows with a narrow high impact stream or turbo nozzle as this may cause breakage. The surest way to avoid damaging surfaces is to follow these steps:

1. Before triggering the gun, adjust the nozzle to a wide fan pattern.
2. Place the nozzle approximately 4-5 feet cleaning surface and begin spraying.
3. Vary the fan pattern spray angle and the distance to the cleaning surface until optimum cleaning efficiency is achieved without damaging the surface.

WATER INLET FILTER

The water inlet filter must be inspected regularly, so as to avoid blockage and restriction in the water supply to the pump (Fig 15).

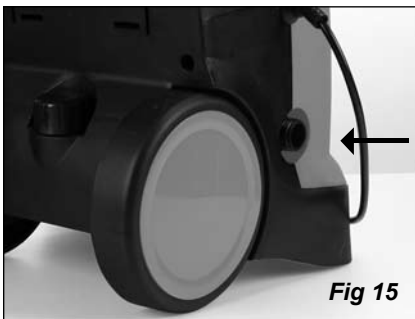

Fig 15

USING DETERGENT

Add detergent to the container (Fig 16) and replace the cap. Pls note the minimum level required, Set the adjustable lance at low pressure position (Fig 14). Depress trigger to spray detergent.



Fig 16

DETERGENTS

The use of detergents can dramatically reduce cleaning time and assist in the removal of difficult stains. Some detergents have been customized for pressure washer use on specific cleaning tasks. These detergents are approximately as thick as water. The use of thicker detergents, such as washing-up liquid, will clog the chemical injection system and prevent the application of the detergent.

The cleaning power of detergents comes from applying them to a surface and giving the chemicals time to break down the dirt and grime. Detergents work best when applied at low pressure. Follow this with a high pressure rinse for best cleaning results. On vertical surfaces, apply the detergent starting at the bottom and work your way upward. This will prevent the detergent from sliding down and causing streaks. High pressure

rinsing should also progress from the bottom upwards. On particularly tough stains it may be necessary to use a brush in combination with detergents and high pressure rinsing.

Operation

The following cleaning procedure will help you organize your cleaning task and ensure that you achieve the most beneficial results in the shortest amount of time. Remember to use the spraying/ cleaning techniques previously listed.

1. Surface preparation

It is important to prepare the surface that is to be cleaned. This is done by clearing the area of furniture and making sure that all windows and doors are closed tight. In addition, you should make sure that all plants and trees adjacent to the cleaning area are protected by a drop cloth. This will ensure that your plants won't be sprayed by the detergents.

2. Initial High Pressure Rinse

The next step is to spray the cleaning surface with water to clear off any dirt or grime that may have collected on the surface. This will allow your detergent to attack the deep down dirt that has worked its way into the cleaning surface. Before triggering the gun, adjust the nozzle to a wide fan pattern and slowly adjust to the desired spray pattern. This will help you avoid applying too much concentrated spray to the surface which could cause damage.

TIPS FOR EXTENDING THE LIFE OF YOUR PRESSURE WASHER

1. Never operate the unit without water.
2. This pressure washer is not designed to pump hot water. Never connect it to the hot water

supply – this will significantly reduce the life of the pump.

WARNING

3. Only use detergents specifically designed for pressure washer. Other types of detergent may cause internal damage to the unit, as might chemicals such as bleach, washing-up liquid, etc.
4. Never operate the unit for more than one (1) minute without spraying water. Otherwise, the resulting heat buildup will damage the pump.
5. Winter Storage:

For storage during the winter months we recommend the use of a solution of 50/50 mix of antifreeze and water. This will keep the pump from freezing and getting damaged and will protect the internal components.

Method: You will need a length of garden hose and a funnel. Attach the garden hose to the inlet and pour the antifreeze into the unit via the funnel.

Switch the unit on for a few seconds to allow the solution to flow through the system. Disconnect your pressure washer from the mains power, then pack away in your storage area.

WARNING: Before reusing completely flush the unit out with plain water. Anti-freeze can damage paintwork so you must ensure there is no anti-freeze left in the system before using it again.

Troubleshooting chart

Symptom	Possible cause (s)	Corrective Action(s)
Pressure washer does not start	<ol style="list-style-type: none"> 1. Unit is pressurized 2. Poor plug connection or faulty outlet socket 3. Extension cord too long or undersized 4. Main voltage supply too low 	<ol style="list-style-type: none"> 1. Squeeze trigger on gun 2. Check plug, socket 3. Remove extension cord 4. Check that main supply voltage is adequate
Pump does not reach necessary pressure	<ol style="list-style-type: none"> 1. Water inlet filter is clogged 2. Pump sucking air from hose connections 	<ol style="list-style-type: none"> 1. Clean water inlet filter 2. Check that connections and locking ring are properly tightened
Fluctuating pressure	<ol style="list-style-type: none"> 1. Pump sucking in air 2. Clogged nozzle 	<ol style="list-style-type: none"> 1. Check that hoses and connections are tight 2. Clear blockage with cleaning needle (see page 5)
Motor stops suddenly	<ol style="list-style-type: none"> 1. Extension cord too long or undersized 	<ol style="list-style-type: none"> 1. Remove extension cord
No detergent suction	<ol style="list-style-type: none"> 1. Using high pressure setting 2. Not enough detergent 	<ol style="list-style-type: none"> 1. Use low pressure setting 2. Add detergent up to min level

Plug fitting

Note: If a moulded plug is fitted and has to be removed take great care in disposing of the plug and severed cable, it must be destroyed to prevent engaging into a socket. If the supply cord is damaged it must be replaced by a service agent or similarly qualified person in order to avoid hazard. Your pressure washer is supplied with a fitted plug, however if you should need to fit a new plug follow the instruction below. If in doubt consult a qualified electrician.

IMPORTANT

The wires in the mains lead are coloured in accordance with the following code:

Blue - Neutral Brown - Live

As the colours of the wires in the mains lead of this appliance may not correspond with the coloured markings identifying the terminals in your plug, proceed as follows:

The wire which is coloured blue must be connected to the terminal which is marked with N.

The wire which is coloured brown must be connected to the terminal which is marked with the letter L.

No connection is to be made to the earth terminal of the plug. If a 13 AMP (BS 1363/A) plug is used, a 13 AMP fuse must be fitted, or if any other type of plug is used a 13 AMP fuse must be fitted, either in the plug, or adaptor or on the distribution board.

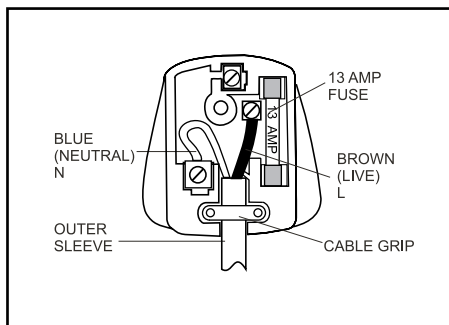

EC DECLARATION OF CONFORMITY

EQUIPMENT: 2400W Pressure Washer
MODEL NUMBER: RAC-HP125
EU REPRESENTATIVE: Hilka Pro Imports
ADDRESS: 1 Roebuck Place
Roebuck Road
Chessington
Surrey. KT9 1EU.
United Kingdom

The Technical documentation is kept by: - as above

This is to certify that the aforementioned equipment fully conforms to the protection requirements of the following EC Council Directives on the approximation of the laws of the member states relating to:

Applicable Directives:

2004/108/EC
2000/14/EC
2006/95/EC
93/68/EEC

And in consideration of the following standards:

EN 50366: 2003 +A1
EN 55014-1:2000+A1+A2
EN 55014-2: 1997+A1
EN 61000-3-2:2000 +A2
EN 61000-3-11:2000
EN 60335-2-79: 2004 +A1
EN 60335-1: 2002 + A1+A11+A12+A2+A13
EN ISO3744

We declare that the above equipment conforms to the requirements of the Directive 2000/14/EC
Sound power level:

Measured	92 dB (A)
Guaranteed	94 dB (A)

The Conformity assessment procedure followed was in according with annex V of Directive 2000/14/EC

This declaration ceases to be valid should there be any modifications or changes to the machine, outside the details in the Instruction Booklet, made by the user.

Signed: _____
(Responsible person)



Position: **Director**

Name: **R.J. Satchell**

Date of issue: *24/04/2009*

WARNING SYMBOLS

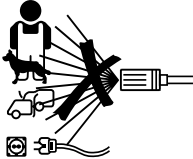
The following warning symbols are to remind you of safety precautions you should take when using this pressure washer

	<p>WARNING:</p> <p>Do not direct the water jet towards other people, animals, the washer itself, its electrical parts, or other electrical equipment.</p>
	<p>WARNING:</p>



This product bears the selective sorting symbol for waste electrical and electronic equipment (WEEE).

This means that this product must be handled pursuant to European Directive 2002/96/EC in order to be recycled or dismantled to minimize its impact on the environment.

For further information, please contact your local or regional authorities.

Electronic products not intended in the selective sorting process are potentially dangerous for the environment and human health due to the presence of hazardous substances.

*If faults cannot be remedied, contact the **Helpline on 020 8391 6767***

Helpline@hilka.co.uk

GUARANTEE

This product is guaranteed for domestic use for a period of 12 months against faulty manufacture or materials. This guarantee does not affect the statutory rights of the consumer. In the event of any problem occurring please contact our Helpline at the number above for advice. This product is not guaranteed for **HIRE** purposes.

Manufactured under license for Hilka Pro Imports.

On behalf of **Home Retail Group**
489 - 499 Avebury Boulevard,
Central Milton Keynes,
MK9 2NW